

BRIVILOR[®]
BONAMAT

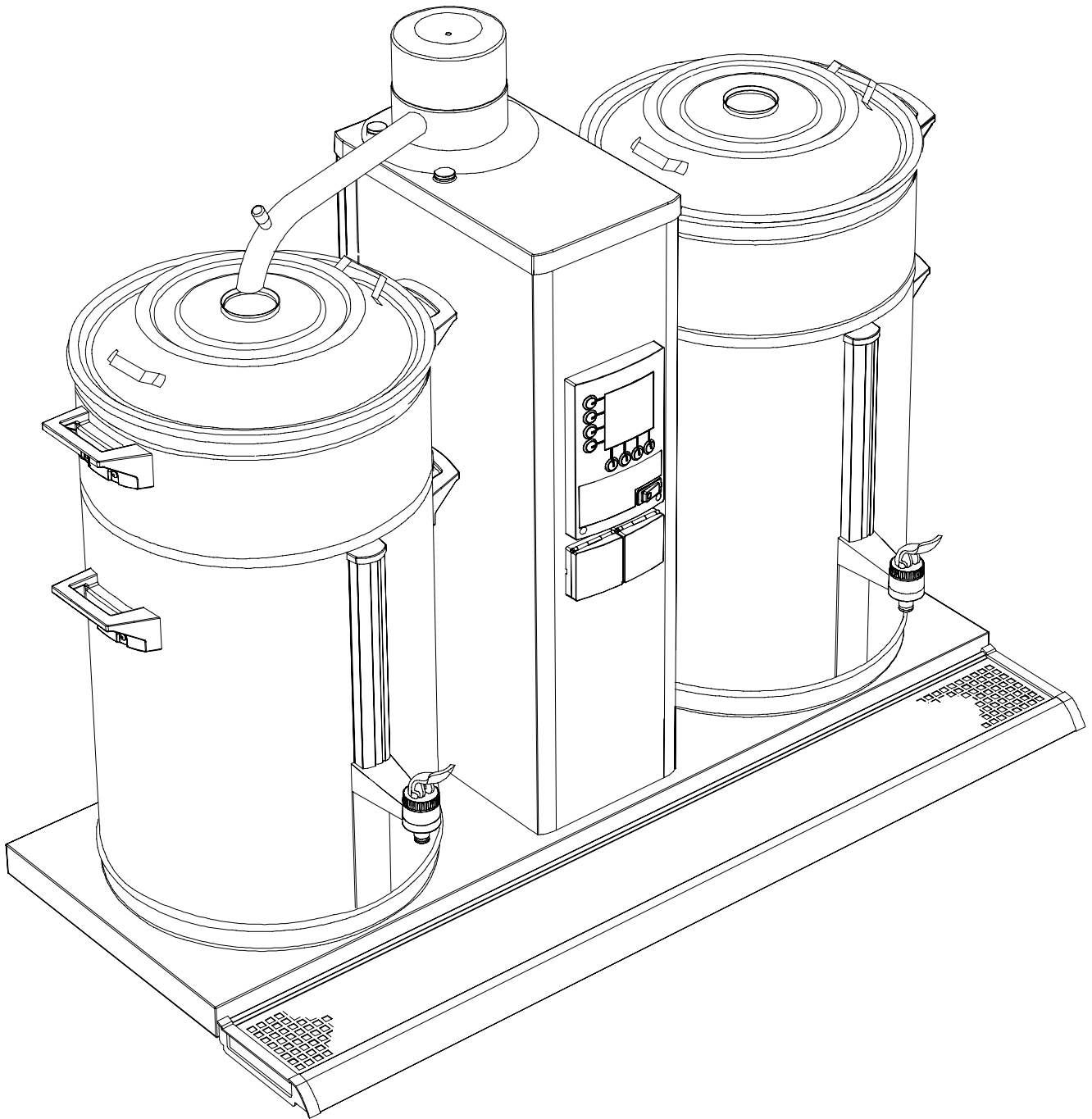





















Operating instructions
Photos

ROUND FILTER COFFEE BREWER



B-series

700.403.800

	English	Türkçe	Русский	Español	日本語	한글	中文
1.	 Use	Kullanım	Использование	Uso	使用	사 용	使用
	 Dripping	Damlama	Капание	Goteo	滴	추 출	滴水
2.	 Cleaning, frequently	Temizleme, sık sık	Очистка, регулярно	Limpieza frecuente	滴	잦은 청소	清潔, 次數
	 Wait	Bekleme	Ожидание	Espera	お待ちください	대 기	等候
	 Acoustic signal	Sesli sinyal	Звуковой сигнал	Señal acústico	音信号	신호음	聽覺信號
3.	 Descaling	Kireçten Arındırma	Удаление накипи	Descalificar	スケール除去	스케일 제거	清除水垢
	 Read Operating Instructions	Kullanma Talimatını Oku	Чтение инструкции в системе горячей воды	Lea instrucciones de uso	取扱説明書参照	취급설명서 참조	閱讀操作說明
4.	 Initial use	İlk kullanım	Первое использование	Uso inicial	使い初め	사용 초기	初次使用
5.	Programming (operator)	Programlama (operatör)	Программирование (оператор)	Programación (operador)	(ユーザー)プログラミング	사용자 프로그래밍	程式(操作)
	 Selection keys	Seçme düğmeleri	Выбор клавиш	Tecla de selección	選択ボタン	선택 키	選擇按鍵
	 Confirm	Onayla	Подтвердить	Confirmar	確定	확 정	確定
	 Cancel	Iptal	Отменить	Cancelar	キャンセル	취 소	取消
	 Water hardness	Suyun sertliği	Жесткость воды	Dureza de agua	水硬度	수질 경도	水的硬度
	 Read Operating Instructions	Kullanma Talimatını Oku	Читайте инструкции	Lea instrucciones de uso	取扱説明書参照	취급설명서 참조	閱讀操作說明
6.	Programming (principal)	Programlama (esas)	Программирование (оператор)	Programación (principal)	(主要な)プログラミング	프로그램밍(원리)	程式(主要的)
	 Selection keys	Seçme düğmeleri	Выбор клавиш	Tecla de selección	選択ボタン	선택 키	選擇按鍵
	 Confirm	Onayla	Подтвердить	Confirmar	確定	확 정	確定
	 Cancel	Iptal	Отменить	Cancelar	キャンセル	취 소	取消
	 Off	Kapali	Выключение	Apagado	オフ	오-프	關閉
	 Min.	En Az	Минимум	Min.	最小	최 소	最小
	 Standard	Standart	Стандарт	Estándar	標準	표 준	標準
	 Max.	En Fazla	Максимум	Max.	最大	최 대	最大
	 Water hardness	Suyun sertliği	Жесткость воды	Dureza de agua	水硬度	수질 경도	水的硬度
	 Read Operating Instructions	Kullanma Talimatını Oku	Читайте инструкции	Lea instrucciones de uso	取扱説明書参照	취급설명서 참조	閱讀操作說明
	Hold 10 sec.	10 san. Tut	Держите 10 секунд	Aguante 10 Segundos	10秒待機	10초간 대기	按著10秒
	Select desired time setting (1-14)	Istenilen zaman ayarını sec (1-14)	Выберите нужное время заваривания 1-14	Selecciona tiempo deseado (1-14)	時間設定(1-14)の選択	시간설정(1-14)의 선택	選擇所需時間設定(1-14)
7.	Error codes	Arıza Kod	Коды ошибок	Códigos de mal función	エラーコード	에러 코-드	錯誤的編號

1. USE (B)

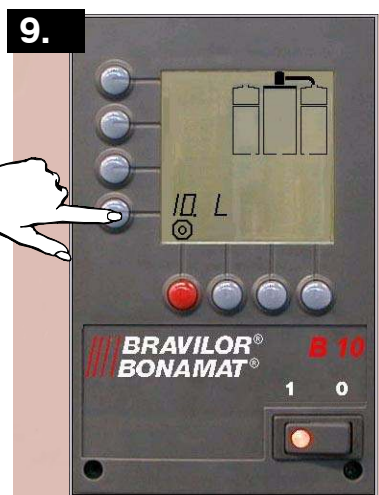
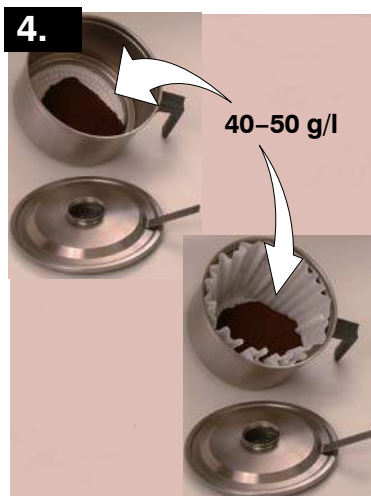
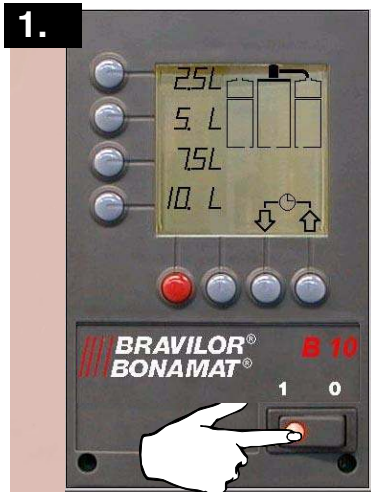

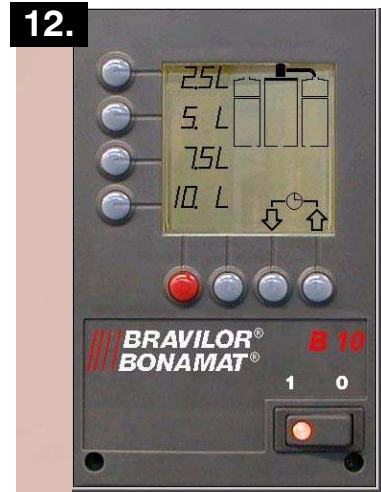

2. CLEANING, FREQUENTLY (B)

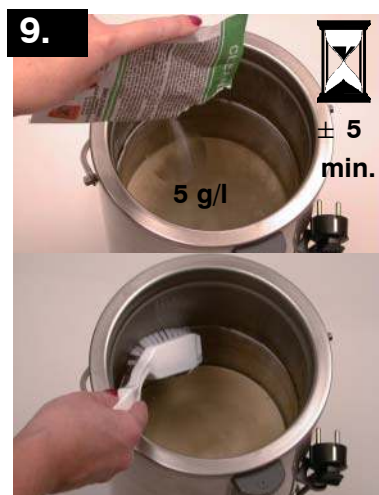
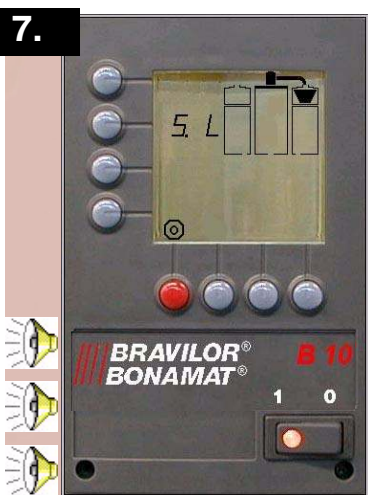
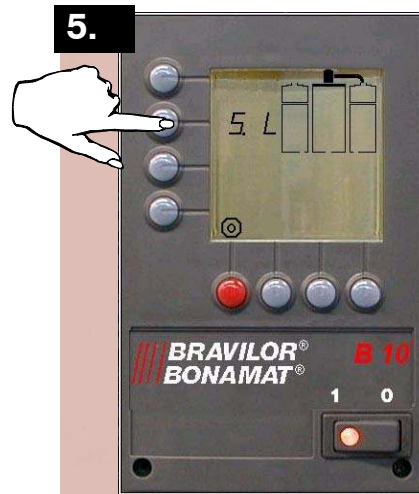
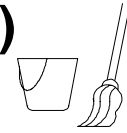

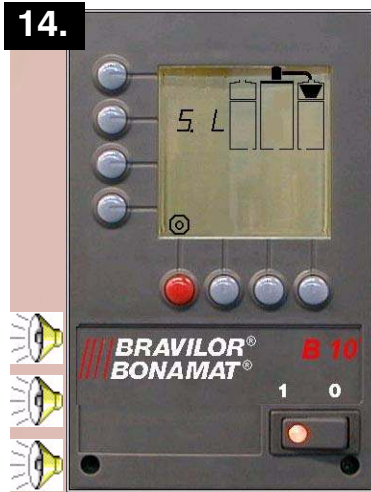



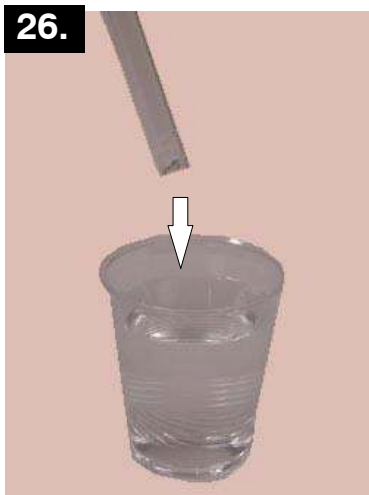

3. DESCALING (B) ± 30 MIN. (OPERATOR)

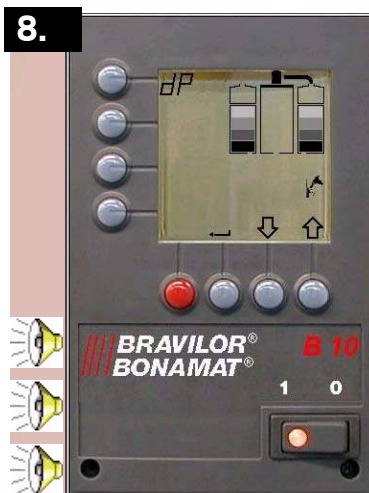
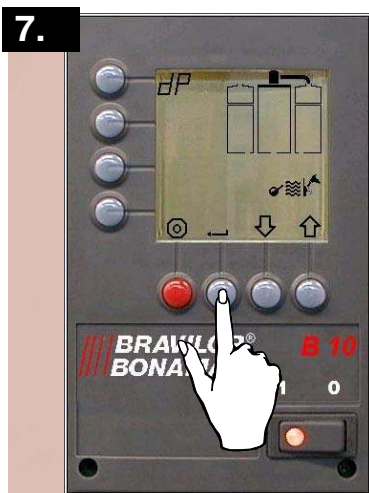
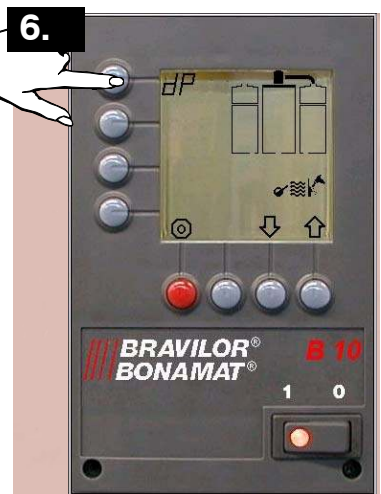
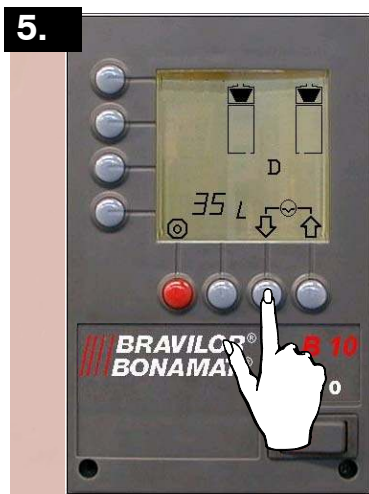
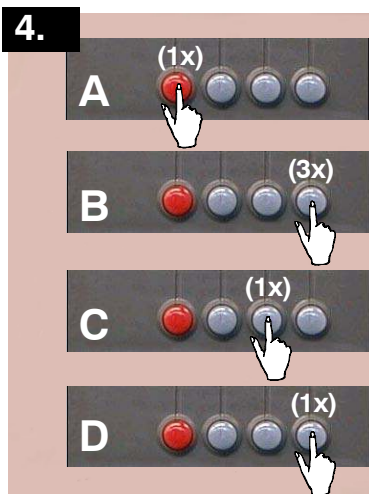

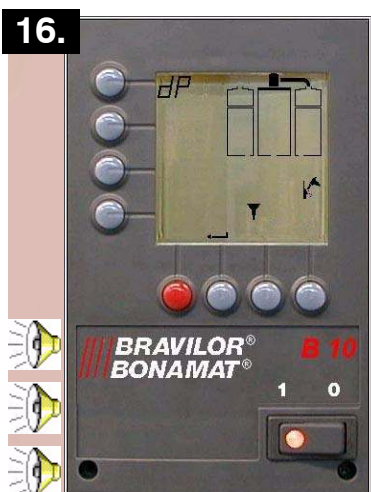
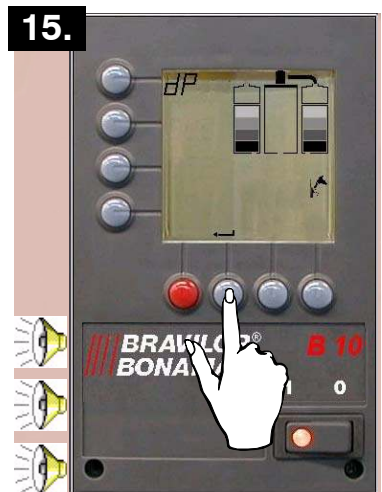
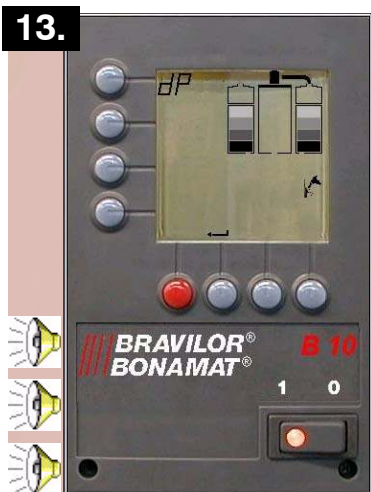
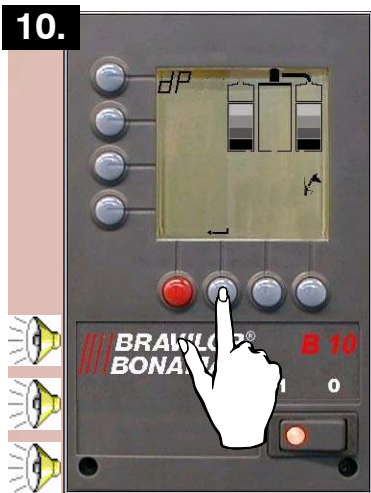

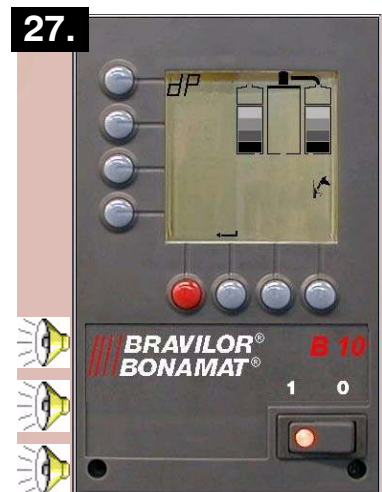
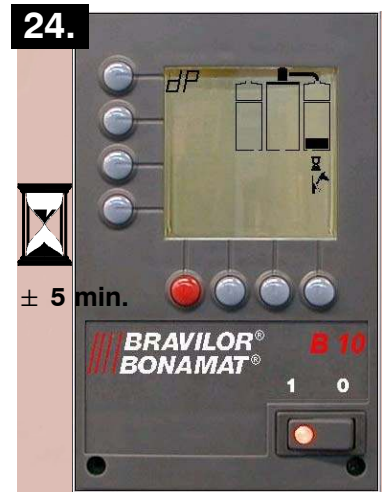
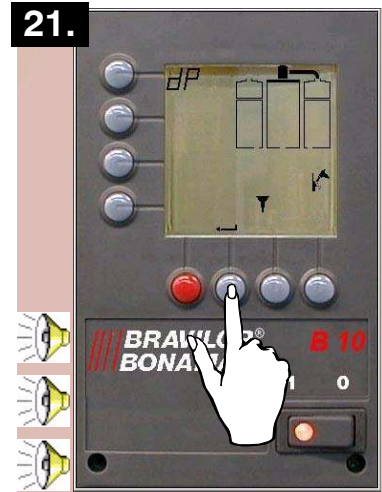

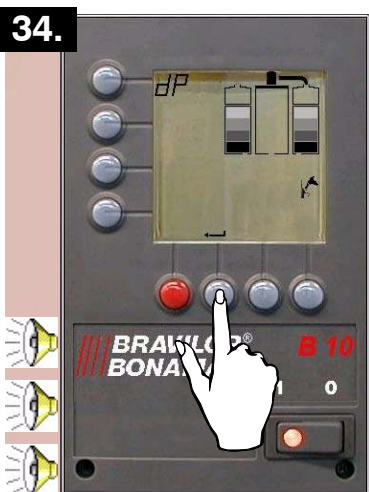
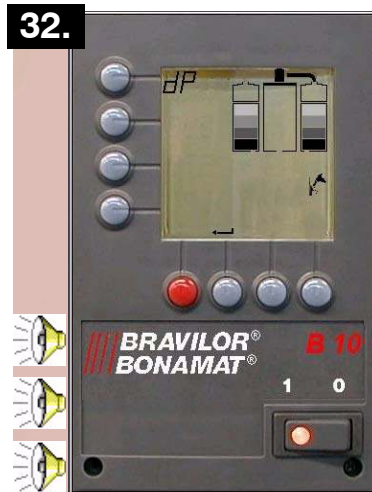
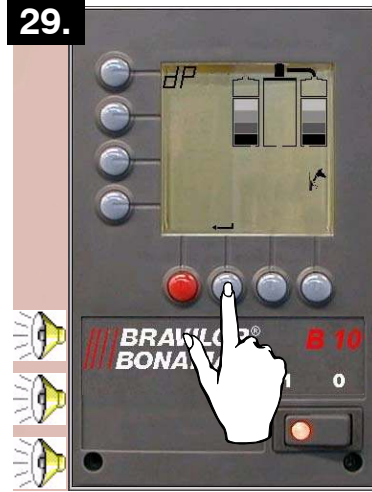

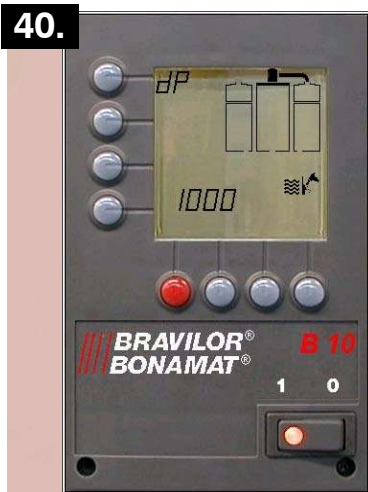
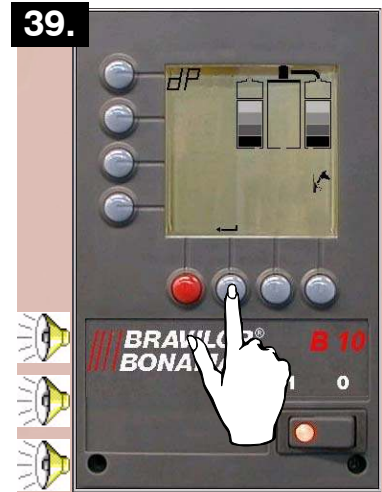
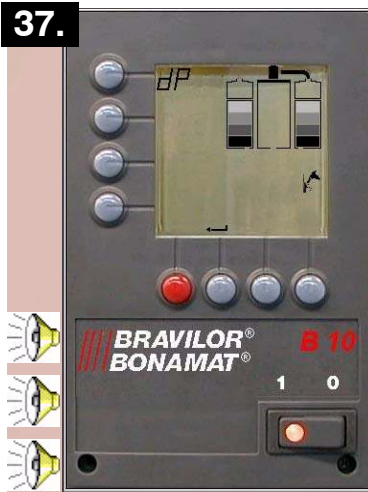



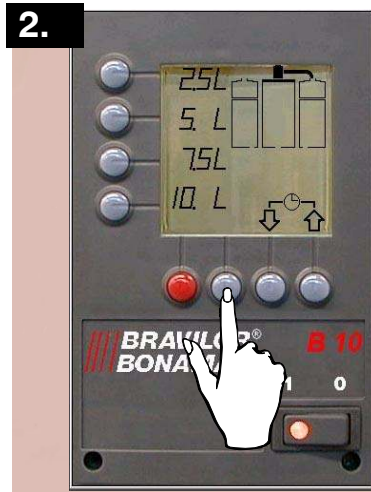
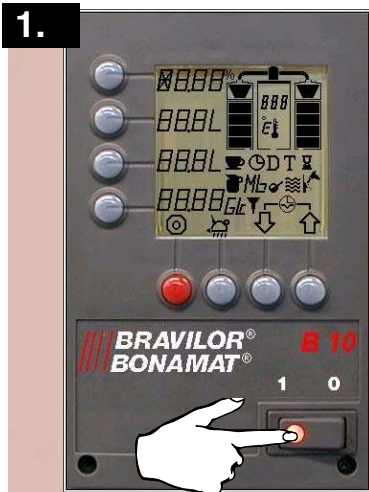

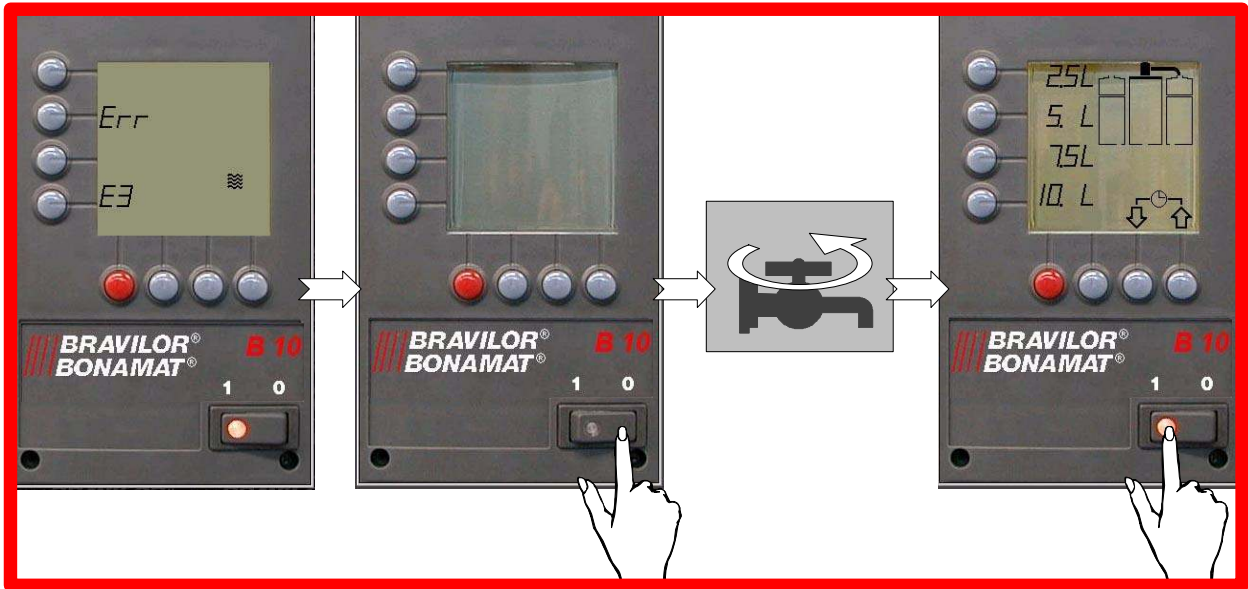

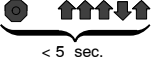
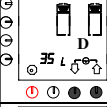

4. INITIAL USE (B)

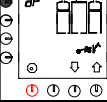

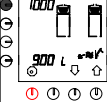



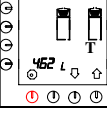





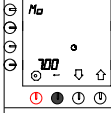
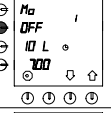

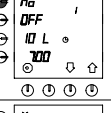
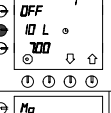
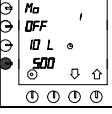

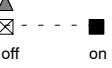

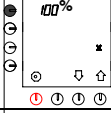
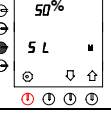





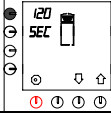

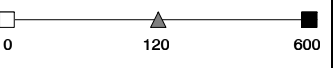

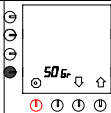

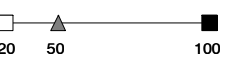

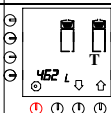

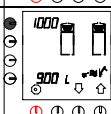
5. PROGRAMMING (B) (OPERATOR)

				 = 0	
				§ 3.	
					
					

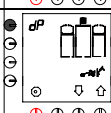
6. PROGRAMMING (B) (PRINCIPAL USER)

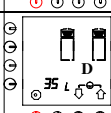
				<table border="1"> <tr><td>B5</td><td>4.8</td><td>5.3</td><td>5.8</td></tr> <tr><td>B10</td><td>10.6</td><td>9.6</td><td>11.6</td></tr> <tr><td>B20</td><td>19.2</td><td>21.2</td><td>23.2</td></tr> <tr><td>B40</td><td>38.4</td><td>42.4</td><td>46.4</td></tr> </table>	B5	4.8	5.3	5.8	B10	10.6	9.6	11.6	B20	19.2	21.2	23.2	B40	38.4	42.4	46.4																																																																																																						
B5	4.8	5.3	5.8																																																																																																																							
B10	10.6	9.6	11.6																																																																																																																							
B20	19.2	21.2	23.2																																																																																																																							
B40	38.4	42.4	46.4																																																																																																																							
				<table border="1"> <tr><td>B5</td><td>1</td><td>1</td><td>3</td><td>4</td><td>5</td><td>5</td></tr> <tr><td>B10</td><td>2</td><td>2.5</td><td>5</td><td>7.5</td><td>10</td><td>10</td></tr> <tr><td>B20</td><td>4</td><td>5</td><td>10</td><td>15</td><td>20</td><td>20</td></tr> <tr><td>B40</td><td>8</td><td>10</td><td>20</td><td>30</td><td>40</td><td>40</td></tr> </table> <table border="1"> <tr><td>50</td><td>125</td><td>200</td></tr> </table> <table border="1"> <tr><td>B5</td><td>8</td><td>8</td><td>24</td><td>32</td><td>40</td><td>40</td></tr> <tr><td>B10</td><td>20</td><td>20</td><td>40</td><td>60</td><td>80</td><td>80</td></tr> <tr><td>B20</td><td>40</td><td>40</td><td>80</td><td>120</td><td>160</td><td>160</td></tr> <tr><td>B40</td><td>80</td><td>80</td><td>160</td><td>240</td><td>320</td><td>320</td></tr> </table> <table border="1"> <tr><td>50</td><td>250</td><td>3000</td></tr> </table> <table border="1"> <tr><td>B5</td><td>4</td><td>4</td><td>12</td><td>16</td><td>20</td><td>20</td></tr> <tr><td>B10</td><td>10</td><td>10</td><td>20</td><td>30</td><td>40</td><td>40</td></tr> <tr><td>B20</td><td>20</td><td>20</td><td>40</td><td>60</td><td>80</td><td>80</td></tr> <tr><td>B40</td><td>40</td><td>40</td><td>80</td><td>120</td><td>160</td><td>160</td></tr> </table> <table border="1"> <tr><td>B5</td><td>0.30</td><td>0.30</td><td>0.65</td><td>0.95</td><td>1.30</td><td>1.30</td></tr> <tr><td>B10</td><td>0.65</td><td>0.65</td><td>1.30</td><td>1.95</td><td>2.60</td><td>2.60</td></tr> <tr><td>B20</td><td>1.30</td><td>1.30</td><td>2.60</td><td>3.95</td><td>5.25</td><td>5.25</td></tr> <tr><td>B40</td><td>2.60</td><td>2.60</td><td>5.25</td><td>7.90</td><td>10.55</td><td>10.55</td></tr> </table>	B5	1	1	3	4	5	5	B10	2	2.5	5	7.5	10	10	B20	4	5	10	15	20	20	B40	8	10	20	30	40	40	50	125	200	B5	8	8	24	32	40	40	B10	20	20	40	60	80	80	B20	40	40	80	120	160	160	B40	80	80	160	240	320	320	50	250	3000	B5	4	4	12	16	20	20	B10	10	10	20	30	40	40	B20	20	20	40	60	80	80	B40	40	40	80	120	160	160	B5	0.30	0.30	0.65	0.95	1.30	1.30	B10	0.65	0.65	1.30	1.95	2.60	2.60	B20	1.30	1.30	2.60	3.95	5.25	5.25	B40	2.60	2.60	5.25	7.90	10.55	10.55
B5	1	1	3	4	5	5																																																																																																																				
B10	2	2.5	5	7.5	10	10																																																																																																																				
B20	4	5	10	15	20	20																																																																																																																				
B40	8	10	20	30	40	40																																																																																																																				
50	125	200																																																																																																																								
B5	8	8	24	32	40	40																																																																																																																				
B10	20	20	40	60	80	80																																																																																																																				
B20	40	40	80	120	160	160																																																																																																																				
B40	80	80	160	240	320	320																																																																																																																				
50	250	3000																																																																																																																								
B5	4	4	12	16	20	20																																																																																																																				
B10	10	10	20	30	40	40																																																																																																																				
B20	20	20	40	60	80	80																																																																																																																				
B40	40	40	80	120	160	160																																																																																																																				
B5	0.30	0.30	0.65	0.95	1.30	1.30																																																																																																																				
B10	0.65	0.65	1.30	1.95	2.60	2.60																																																																																																																				
B20	1.30	1.30	2.60	3.95	5.25	5.25																																																																																																																				
B40	2.60	2.60	5.25	7.90	10.55	10.55																																																																																																																				
				<table border="1"> <tr><td>88</td><td>97</td><td>97</td></tr> </table> <table border="1"> <tr><td>190</td><td>206</td><td>206</td></tr> </table>	88	97	97	190	206	206																																																																																																																
88	97	97																																																																																																																								
190	206	206																																																																																																																								
				<p>▲ EnG</p> <p>□ ■ dEu, FrA, ESP, nEd</p> <p>▲ □ - - - - - ■ off on</p>																																																																																																																						

			Select desired time setting (1-14). 						 off on
									
									
									
									
									
						§ 3. (Operator)			
						= 0			

7. ERROR CODES (B)

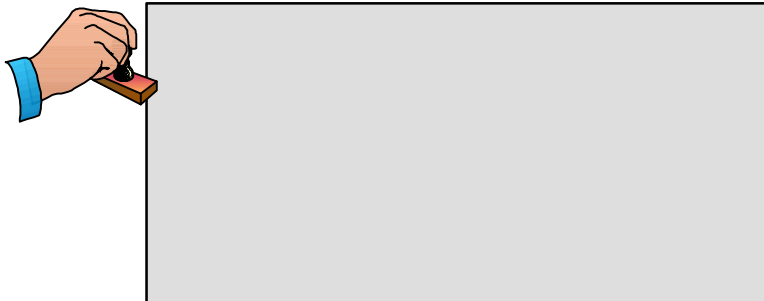
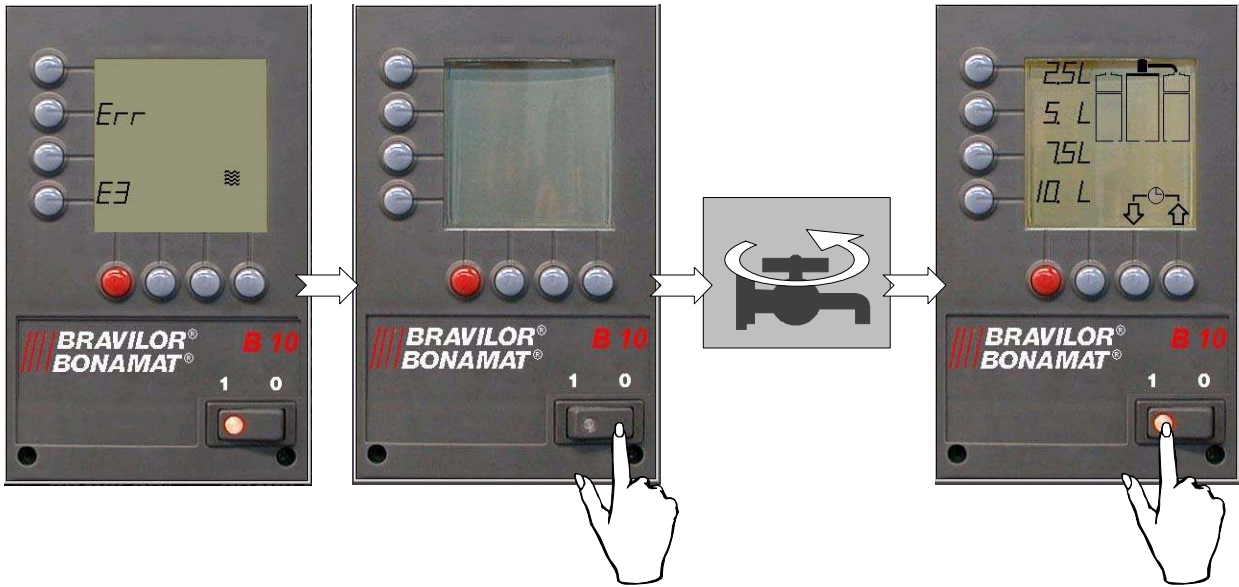



**/// BRAVILOR[®]
BONAMAT**

COFFEE BREWING MACHINES
MACHINES A CAFE
KAFFEEBRUEHMASCHINEN
KOFFIEZETAPPARATEN

© 11-2001

700.403.800